



# **JUNIOR HOOP**

*Internal Jack Adjustable  
Height Goal System*



*Installation  
& Owner's  
Instructions*



*Made In The USA*

*Best in Basketball*



## *Junior Hoop Internal Jack System Instructions*

This manual explains the proper installation, operation and maintenance of your Goalsetter Goal. Study and understand these instructions thoroughly before installing or operating the goal. Failure to do so could result in serious injury or death and/or equipment damage. Consult your Goalsetter dealer or Goalsetter Systems, Inc. if you do not understand the instructions in this manual or need additional information.

Goalsetter Systems, Inc. recommends that you retain this manual for future reference of operation, maintenance and parts information.

The instructions, illustrations and specifications in this manual are based on the latest information available at the time of publication. Your goal may have product improvements and options not yet contained in this manual.

Goalsetter Systems, Inc. reserves the right to make changes at any time without notice or obligation.

Additional copies of these instructions are available from Goalsetter Systems, Inc.

GOALSETTER<sup>®</sup>, GOALSETTER SYSTEMS<sup>®</sup> AND GOALSETTER<sup>®</sup> logo are all registered trademarks of Goalsetter Systems, Inc. in the U.S. and/or other countries.

GS<sup>™</sup> and BEST IN BASKETBALL<sup>™</sup> are trademarks of Goalsetter Systems, Inc.

This product is covered by various U.S. and Canadian patents, including U.S. Patent #5,211,393.  
Patent infringement will be prosecuted.

No part of this manual may be reproduced in any form or by any means electronic or mechanical, including photocopying, recording, or by any information storage and retrieval systems without the express written consent of Goalsetter Systems, Inc.

**Copyright 2006.  
Revised 12/22/2008.  
All Rights Reserved.  
Goalsetter Systems, Inc.**

**Questions? Comments? Contact Us:  
Phone: 800.362.4625 • Fax: 641.594.3343  
Email: [info@goalsettersystems.com](mailto:info@goalsettersystems.com)  
[www.goalsettersystems.com](http://www.goalsettersystems.com)**

**TABLE OF CONTENTS**

**Contact Information** .....2

**Safety Instructions** .....4

**Goal Specifications** .....7

**Goal Assembly** .....4

    Required Tools and Materials .....6

    Hardware Identification .....5-6

    Parts List – Mini Hoop .....8-9

    Pole Assembly .....10

    Backboard Attachment .....11

    Goal Alignment .....12

    Rim Attachment .....12

    Height Indicator Attachment .....13

    Permanent Crank Handle Attachment .....13

**Operation and Maintenance** .....14-15

    Operation .....14

    Cleaning .....14

    Maintenance .....15

    Lubrication .....15

**Warranties** .....16

**THANK YOU!**

*Thank you and congratulations for purchasing a Goalsetter Goal – the finest basketball goal system on the market today! You will discover that Goalsetter is unsurpassed in product innovation, quality and integrity in the basketball equipment industry. We are continually focused on designing, engineering and producing products that meet and exceed the expectations of today’s toughest playing environments and demanding players.*

## SAFETY INSTRUCTIONS

**Failure to follow these safety instructions may result in serious injury or death and/or property damage.**

- Do not install or use this product unless the instructions within this manual have been carefully read and understood.
- Consult your Goalsetter dealer or Goalsetter Systems, Inc. if you do not understand the instructions in this manual or need additional information.
- Before digging for the ground anchor, contact your local One-Call system in your area.
- Installation and assembly of this product will require lifting and bending that may result in injury to anyone not accustomed to this type of activity.
- Climate, corrosion or misuse could result in system failure.
- DO NOT HANG on the rim or any part of the goal system. This includes the backboard, support braces or net.
- During play, especially when performing dunking activities, keep the player's face away from the backboard, rim and net. Serious injury could result if teeth/face come in contact with the backboard, rim or net. Do not wear jewelry or other loose objects that could become entangled in the net.
- Twice yearly, check the goal system for loose hardware, excessive wear and signs of corrosion. Repair the system before use.
- Never play on damaged equipment.

### WARNING

**FAILURE TO FOLLOW THESE WARNINGS MAY RESULT IN SERIOUS INJURY AND/OR PROPERTY DAMAGE.**

*Owner must ensure that all players know and follow these rules for safe operation of the system.*

- DO NOT REMOVE OR COVER THIS WARNING LABEL
- DO NOT HANG on the rim or any part of system including backboard, support braces or net.
- During play, especially when performing dunk type activities, keep player's face away from the backboard, rim and net. Serious injury could occur if teeth/face come in contact with backboard, rim or net.
- Do not slide, climb or play on pole.
- Do not allow young children to adjust system.
- During play, do not wear jewelry (rings, watches, necklaces, etc.). Objects may entangle in net.
- Keep organic material away from pole base. Grass, litter, etc. could cause corrosion and/or deterioration.
- Check pole system for signs of corrosion (rust, pitting, chipping) and repaint with exterior enamel paint. If rust has penetrated through the steel anywhere, replace pole immediately.
- Check system before each use for loose hardware, excessive wear and signs of corrosion and repair before use.
- Never play on damaged equipment.

GOALSETTER SYSTEMS, INC.

1-800-362-4625

## GOAL ASSEMBLY

**IMPORTANT:** Safe assembly of the goal requires two to three people in good physical condition and capable of lifting 80-100 lbs (36-45 kg) each.

**IMPORTANT:** Locate and familiarize yourself with all parts of the goal before beginning assembly.

### Required Tools and Materials

Level	Ratchet
Rubber Mallet	9/16" and 3/4" Sockets
12' Tape Measure	9/16" and 3/4" Wrenches
Phillips Screwdriver	

# HARDWARE IDENTIFICATION

Refer to pages 8-9 for descriptions, model usage and quantities.

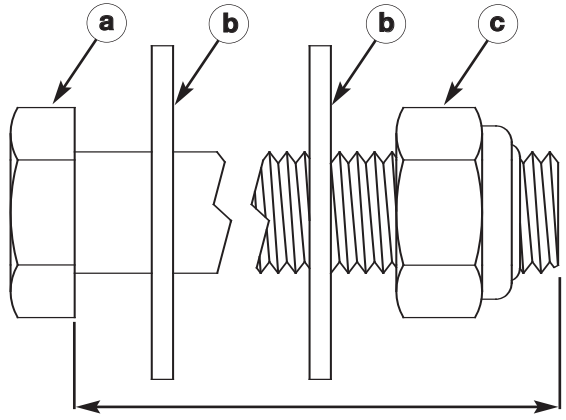
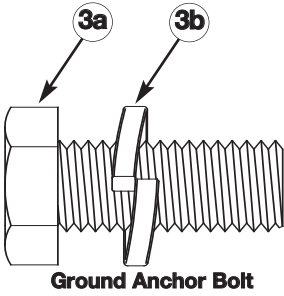

Description	Model	Parts List Callout	Length
Backboard Bolt	Mini Hoop	#10	2"

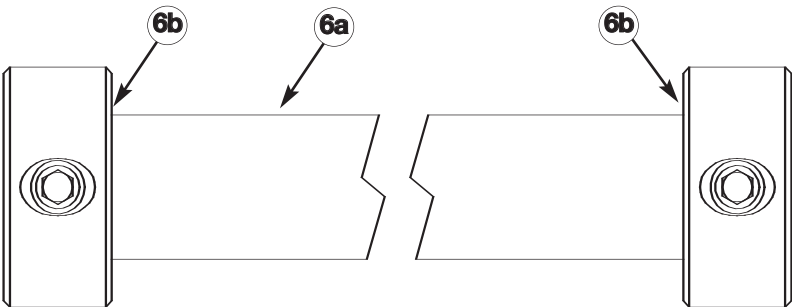
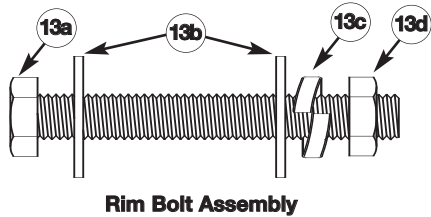
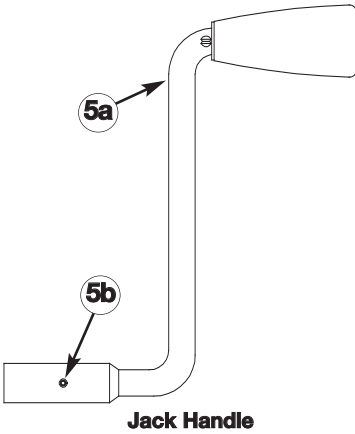

**Extension Arm To Pole Pivot Pin Assembly – 1/2" dia. x 6-1/2"**

## HARDWARE IDENTIFICATION

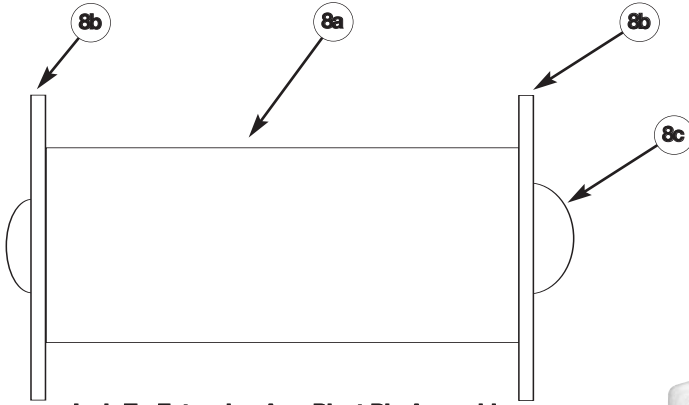

**Jack-To-Extension Arm Pivot Pin Assembly**

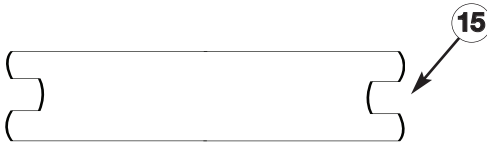

**Grommet**



**Black Touch-Up  
Paint**

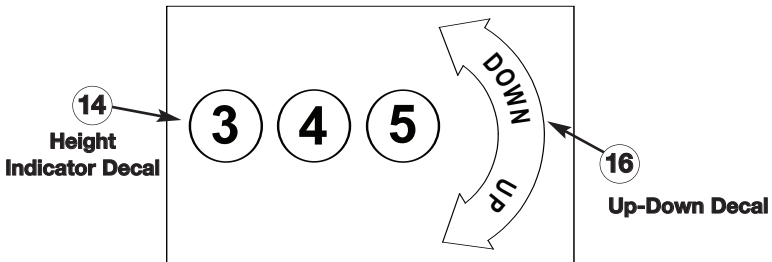

**14**  
Height  
Indicator Decal

**16**  
Up-Down Decal

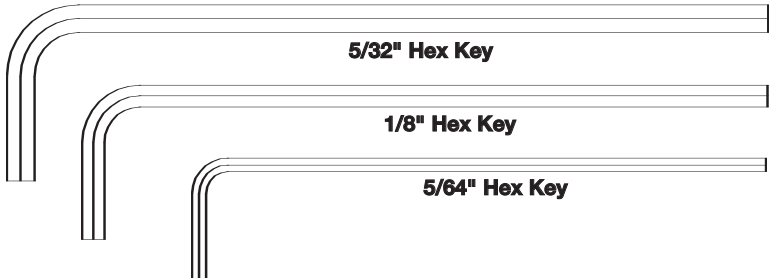

**5/32" Hex Key**

**1/8" Hex Key**

**5/64" Hex Key**

# GOAL SPECIFICATIONS

## Junior Hoop

Pole Size.....3" x 3"  
 Backboard Size .....25" x 36"  
 Weight with Glass .....111 lbs.  
 Height Range (A) .....3' – 5'  
 Extension Distance (B) at .....3': 24"  
 .....4': 27-3/4"  
 .....5': 27-1/2"

Rim to Top-of-Goal Distance (C) .....20"  
 Crank Distance (D) .....9"  
 Crank Height (E) .....16"  
 Offset Height (F) .....42-1/4"  
 Pole Height (G) .....62-3/4"  
 Offset Distance (H) .....12"

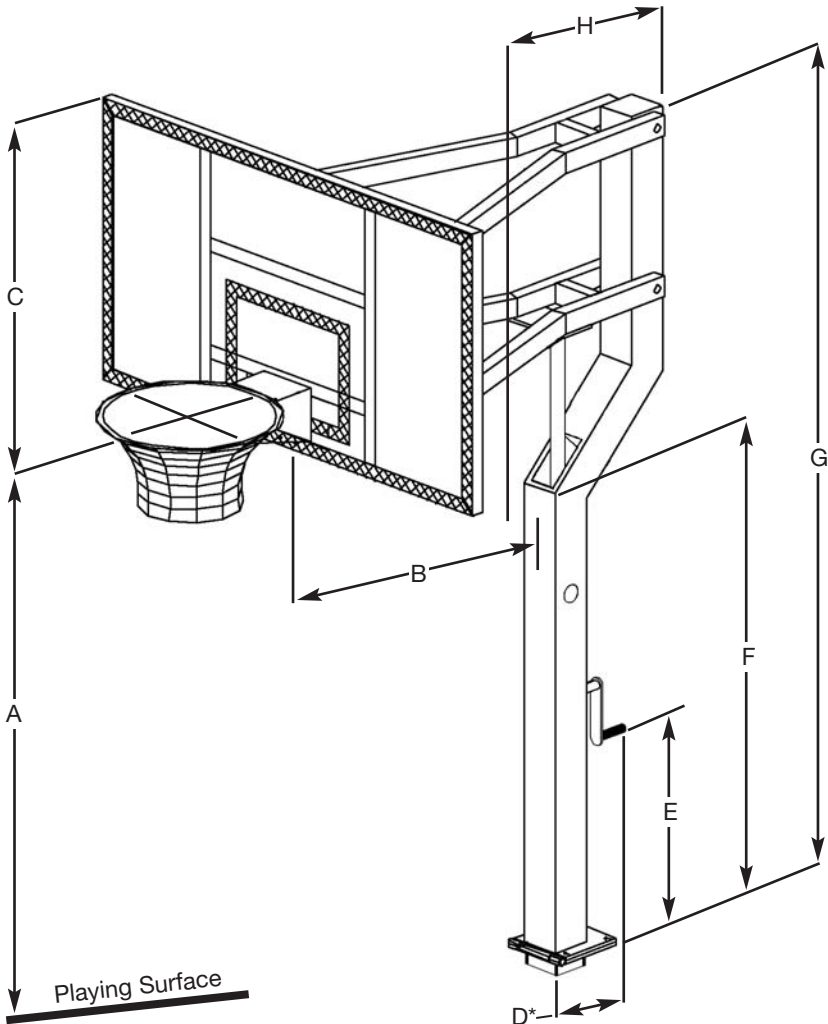

## PARTS LIST – JUNIOR HOOP

**NOTE:** Refer to page 15 for parts descriptions.

**NOTE:** Refer to page 9-11 for hardware descriptions.

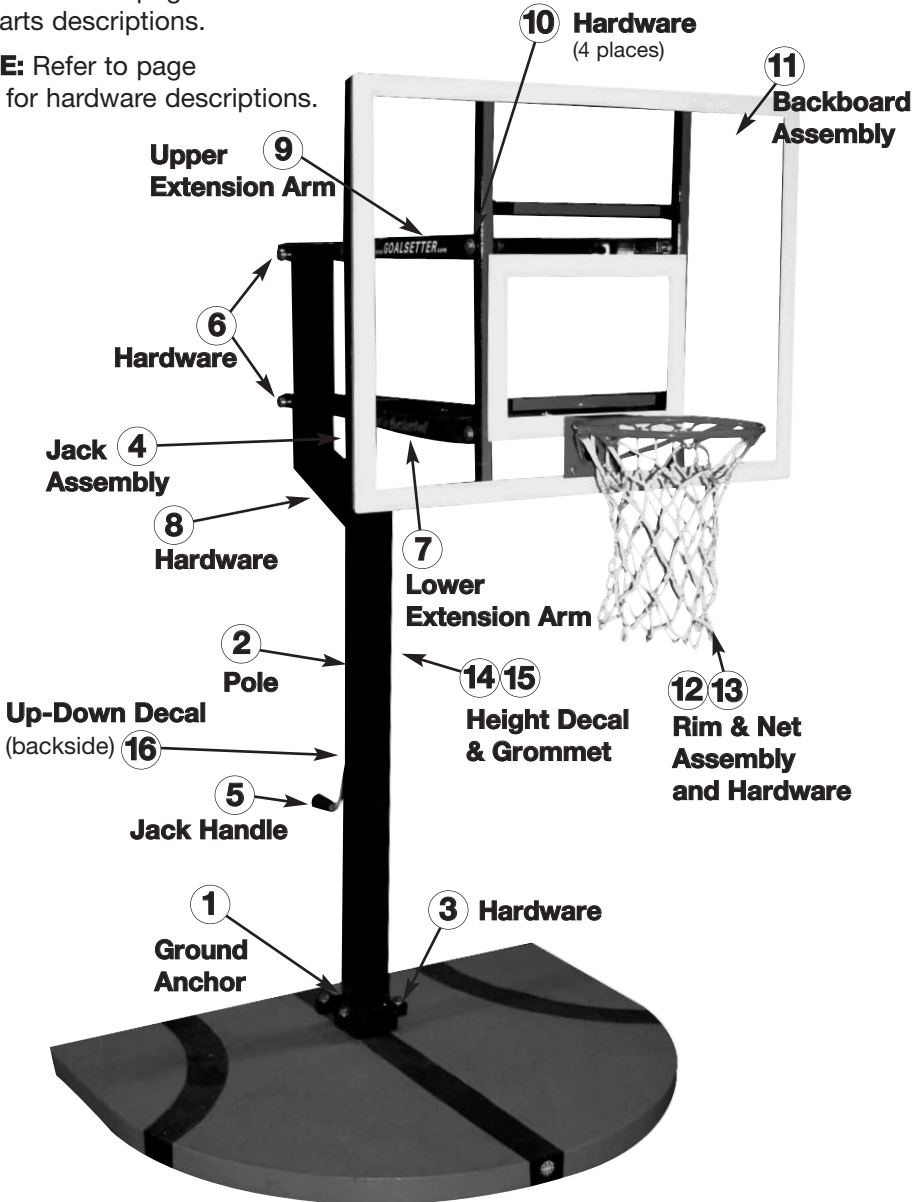

## PARTS DESCRIPTION

REF	MINI HOOP	DESCRIPTION
<b>1</b>	1	Ground Anchor
<b>2</b>	1	Pole – 3" x 3"
<b>3a</b>	5	Bolt, 1/2"-13 UNC x 1-1/4"
<b>3b</b>	5	Lock Washer, 1/2"
<b>4</b>	1	Jack Assembly
<b>5a</b>	1	Jack Handle
<b>5b</b>	2	8-32 Setscrew
<b>6a</b>	2	1/2" dia. x 6-1/2" Pivot Pin
<b>6b</b>	4	1/2" I.D. Set Collar
<b>7</b>	1	Lower Extension Arm
<b>8a</b>	1	5/8" dia. x 1-5/16" Pivot Pin
<b>8b</b>	2	Fender Washer, 1-1/2" OD x 5/16"
<b>8c</b>	2	Socket Screw, 1/4"-20 x 1/2" SS BH
<b>9</b>	1	Upper Extension Arm
<b>10a</b>	4	Bolt, 3/8"-13 UNC x 2"
<b>10b</b>	8	3/8" Flat Washer
<b>10c</b>	4	3/8" Locknut
<b>11</b>	1	Backboard Assembly, 25" x 36"
<b>12</b>	1	Rim and Net Assembly
<b>13a</b>	4	Bolt, 3/8"-16 UNC x 2"
<b>13b</b>	8	Flat Washer, 3/8"
<b>13c</b>	4	Lock Washer, 3/8"
<b>13d</b>	4	Flange Nut, 3/8"-16 UNC
<b>14</b>	1	Decal, Height Indicator
<b>15</b>	1	Grommet
<b>16</b>	1	Decal, Up-Down

## POLE ASSEMBLY

**Step 1:** Remove five plastic plugs from threaded holes in ground anchor.

**NOTE:** Use protective padding to protect pole finish.

**Step 2:** Unpack pole and jack.

**NOTE:** On the all models, the jack assembly is already installed in the pole.

**Step 3:** Locate five 1/2" x 1-1/4" bolts **1** (#3 in parts list). Prepare them for use by having lock washer **2** slipped on as shown.

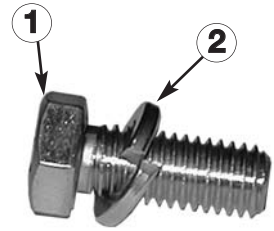

**Step 4:** Fasten pole **3** to threaded ground anchor plate **4** as follows:

- First, install and tighten three back bolts **5** with lock washers.
- Then, install and tighten two front bolts **6** with lock washers.

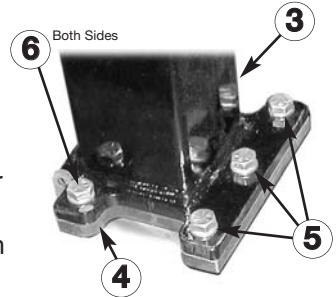

**Step 5:** Fully tighten five bolts.

**IMPORTANT:** The bolts must pass all the way through the ground anchor plate. If they are recessed within the plate when fully tightened, please contact Goalsetter Systems.

**Step 6:** Pull jack assembly **7** out slightly, remove packing and protective materials from end of jack and reposition jack in pole.

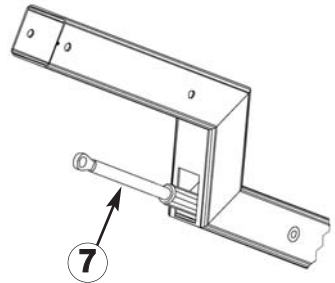

**Step 7:** Insert crank handle through access hole **12** and slide onto shaft.

**NOTE:** If a permanent crank handle installation is desired, refer to Permanent Crank Handle Attachment.

**Step 8:** Position lower extension arm **8** with clevis **9** toward pole offset. Align lower extension arm pivot holes with lower holes **10** in pole.

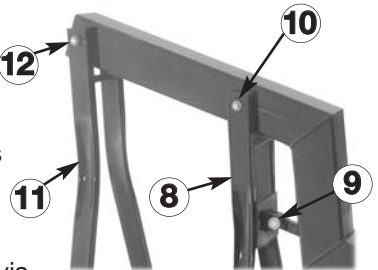

## POLE ASSEMBLY (cont.)

**Step 9:** Attach lower extension arm to pole using the following:

**Mini Hoop:** 1/2" x 6-1/2" pin and two lock collars (#6 in parts list). Tighten with 1/8" hex key (provided).

**Step 10:** Attach upper extension arm **11** pivot holes with upper holes **12** in pole.

Attach arm to pole using the following:

**Mini Hoop:** 1/2" x 6-1/2" pin and two lock collars (#6 in parts list). Tighten with 1/8" hex key (provided).

**Step 11:** Attach upper mount of jack to lower extension arm using the following:

**Mini Hoop:** 5/8" x 1-5/16" pin, two fender washers, and two 1/2" socket screws (#8 in parts list). Tighten with 5/32" hex key (provided).

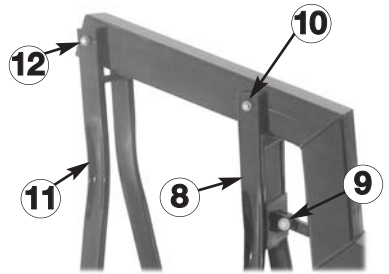

## BACKBOARD ATTACHMENT

**Step 1:** Open lid of box containing backboard **1** and position the backboard (without removing it from box) face down under lower extension arm **2** with rim mounting plate **3** toward pole.

**NOTE:** Backboards are attached to extension arms using the following:

**Mini Hoop:** Four 3/8" x 2" bolts, eight flat washers and four locknuts (#10 in parts list).

**Hardware Sequence:** Bolt passes through flat washer - arm bracket - backboard bracket - flat washer - locknut.

**Step 2:** Align lower backboard holes **4** with **lower** extension arm holes **2**. Attach backboard to arm using

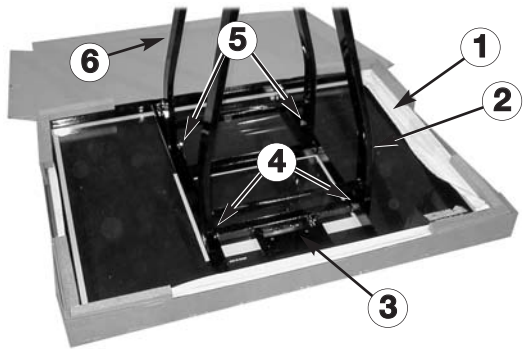

hardware noted above.

**Step 3:** Align upper backboard holes **5** with **upper** extension arm holes **6**. Attach backboard to arm using hardware noted above.

**NOTE: Junior Hoop:** Do not over tighten. Snug tighten only.

## GOAL ALIGNMENT

**Step 1:** Check goal assembly with a level and inspect visually to determine if it is parallel and plumb to playing surface.

**Step 2:** If adjustments are necessary, slightly loosen bolts to rotate goal or place shims between pole plate and ground anchor plate.

## RIM ATTACHMENT

**Step 1:** Remove any cardboard edge protectors and protective sheeting from backboard.

**NOTE:** Four steel shouldered bushings ① are factory installed. If loose, make sure to have them seated properly when tightening rim bolts. If missing, contact Goalsetter or dealer to get replacements. **DO NOT install rim without bushings.**

**IMPORTANT:** Correct sequence of hardware installation MUST be followed during assembly.

**Step 2:** Loosely attach rim ④ to backboard through top mounting holes ② with two 3/8" x 2" bolts (#13 in parts list), four flat washers, two lock washers and two nuts. Snug tighten hardware – a 9/16" open-end wrench may be necessary.

**Hardware Sequence:** Bolt passes through flat washer - rim backplate - backboard bushing - backboard mounting plate - flat washer - lock washer - nut.

**Step 3:** Repeat procedure outlined in Step 2 for lower rim mounting holes ③.

**Step 4:** Level rim side to side and then fully tighten hardware.

**Step 5:** Attach net to rim.

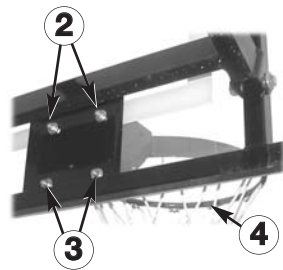
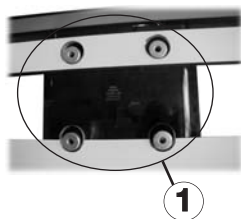

## HEIGHT INDICATOR ATTACHMENT

**Step 1:** Position top of rim 3' above playing surface using crank handle. Measure distance with a tape measure for accuracy.

**Step 2:** Insert height decal ① with printed number '3' through indicator hole in pole and attach to internal height indicator plate.

**Step 3:** Repeat steps for 4', and 5' rim heights. Use height decals with printed numbers '4' and '5'.

**Step 4:** Install rubber grommet ② into indicator hole.

**Step 5:** Attach UP/DOWN decal ③ to pole above crank handle hole.

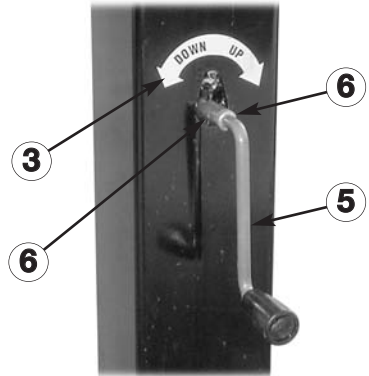
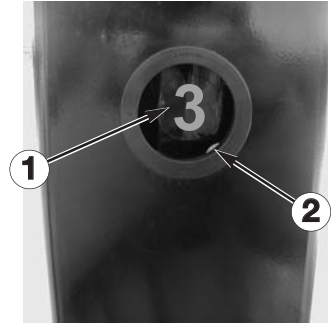

## PERMANENT CRANK HANDLE ATTACHMENT

**Step 1:** Insert shoulder bolt jack shaft extension ④ into tapped hole on jack shaft. Tighten with 1/8" hex key (provided).

**Step 2:** Attach handle ⑤ to shaft using set screws ⑥ and 5/64" hex key (provided).

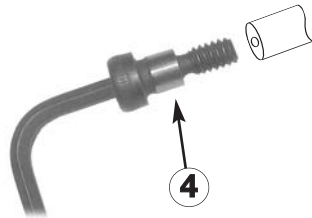

## OPERATION

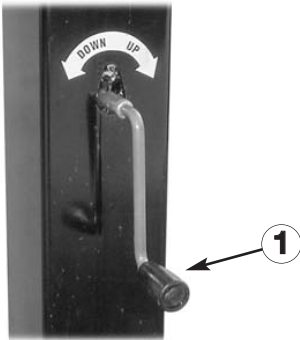

① Crank – Turn clockwise for goal to go up, turn counter clockwise for goal to go down.

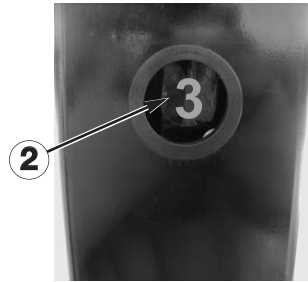

② Height Indicator indicates goal height from 3' to 5'.

## CLEANING

The exterior finish of your Goalsetter goal is designed for outdoor environments and should only require periodic cleaning and inspection for imperfections that could develop over time (see *Maintenance* section).

When cleaning is necessary, Goalsetter recommends using water and a mild dish detergent applied with a soft, non-abrasive cloth.

**IMPORTANT:** DO NOT use abrasive cleaners to clean the goal. Damage to the finish may result.

## MAINTENANCE

Goalsetter uses a two-part acrylic-enamel paint on our goals. With periodic inspection and service when needed, the high-gloss finish is designed to last for many years. A small bottle of black paint with brush is provided with every goal for touch up of imperfections as they develop and can be found in the hardware kit.

If more touch up is required, please contact Goalsetter Systems, Inc. or your local Goalsetter Dealer.



## LUBRICATION

Every jack that comes with a Goalsetter height-adjustable goal is pre-lubricated as it comes from the factory. With any mechanical component, periodic inspection and service is required. Goalsetter recommends applying lubrication at least once or twice a year to keep a smooth operation of the height actuator. Failure to do so could result in jack failure and not be covered under warranty.



### ① Jack Assembly

**The Junior Hoop is equipped with a lubrication port.** Use a liberal amount of general-purpose lubricating oil. **DO NOT** use a penetrating oil.

**IMPORTANT** – A general-purpose lubricating oil like “3-in-1” or lightweight motor oil is recommended. **DO NOT** use penetrating oil like “WD-40”. Goalsetter has “Maintenance Kits” available which would include a bottle of lubricating oil. Contact Goalsetter Systems, Inc. or your local Goalsetter Dealer for details.

# WARRANTIES

## BUYER AGREES THAT PRODUCTS SOLD BY GOALSETTER SYSTEMS, INC. CARRY THE FOLLOWING WARRANTY

Subject to proper installation and normal, intended use, all structural components of Goalsetter Systems **Signature Series\***, **Extreme Series\*** and **GS Wall-Mount Series\*** basketball systems are warranted to be free of defects in material and workmanship for the duration of ownership by the original retail purchaser, subject to the limitations below. **Tournament Series\*** systems will be covered by this warranty for a period of five years. **GS Portable Series\*** and **Goalsetter Mini Hoop** systems will be covered by this warranty for a period of two years. Goalsetter shall have the right to require the purchaser to deliver the allegedly defective product to Goalsetter for testing, repair or replacement. Goalsetter shall not be responsible for any expenses associated with the replacement or removal of the product from its application for such delivery. Modification of any product by the customer, unless approved by Goalsetter Systems, will void all warranty. Where listed as "LIMITED", the warranties shall cover damage or failure that occurs during the course of **NORMAL or INTENDED USE** of the product. Normal or intended use shall be described as activity that is necessary for the participation in the sport for which the equipment is designed. **NOT COVERED** is damage caused by deliberate hanging, multiple player hanging, vandalism, non-basketball activities or any other activity that could be regarded as abusive. \*Signature Series – MVP, Captain, All-American, All-Star, Contender, Champion; Extreme Series – X672, X660, X560, X554, X454, X448; GS Wall-Mount Series – GS72 Wall-Mount, GS60 Wall-Mount, GS54 Wall-Mount, GS48 Wall-Mount; Tournament Series – Elite, Classic; GS Portable Series – GS1000, GS2000, GS2500, GS3000, GS3500

**Any warranty on a basketball system excludes the rim. Rim warranties are as follows:** Single Ring Static Rim: two-year limited; Double Ring Static Rim: Unconditional Lifetime; Home Court Flex Rim: one-year limited; Heavy Duty Flex Rim: two-year limited; GS Ultra Flex Rim: five-year limited; GS Collegiate Breakaway Rim: five-year limited; Double Ring Static Galvanized Rim: Unconditional Lifetime

**Padding Warranty:** Multi-Purpose Backboard Edge Padding: one-year limited; Indoor Backboard Edge Padding: five-year limited (indoor only); Custom Fitted Pole Padding: one-year limited; Wrap Around Pole Padding: one-year limited

### NOT COVERED BY THIS WARRANTY

- Use in non-residential applications of Glass backboards on Signature Series systems.
- Use in non-residential applications of Extreme Series and Tournament Series complete systems.
- Any products subjected to abuse, negligence, improper installation, vandalism, acts of God, alteration of product or any other events beyond the control of Goalsetter Systems.
- Paint or rusted parts. Touch-up paint is included in all hardware kits.
- Deterioration of product due to time or wear and tear.

Normal deterioration of products due to atmospheric conditions, weather, wear and tear (including paint), or other causes that do not affect functional use are not covered by Goalsetter Systems warranties. All warranties are valid only when product is used in the intended application & when installed according to Goalsetter Systems instructions. Warranty may be void if maintenance instructions in the Owner's Manual are not followed. If you did not receive an Owners Manual please call 1-800-362-4625 and one will be mailed to you.

**WARRANTY CLAIMS:** All returns must be arranged through the Goalsetter Systems dealer where the product was originally purchased. Warranties do not cover dealer service charges, labor charges, freight charges and travel expenses associated with replacement, repair or removal of warranty item. A Goalsetter Warranty Claim form must be completed, and photos submitted, for any item you wish to claim under warranty. If the purchase was not made through a dealer, this form is available by email, fax or mail. In response to your claim, you will receive an order confirmation as well as a notice stating whether Goalsetter needs your warranty item returned. Goalsetter will notify you by fax or phone if we determine that the item cannot be claimed under warranty. **Goalsetter Systems is not responsible for any charges for labor to install or repair defective product without prior authorization. Goalsetter will determine the most economical method to either repair or replace product before any work is to commence.**

### MISC PRODUCT WARRANTIES

**Other Portable Systems:** GS4500 – 5 year limited; GS5000 – Base – 10 year limited, Pole, Backboard, Hand Crank, Padding and Rim – 5 year limited; GS6000 & GS7000 – Portable Structure – 10 year limited, Backboard – Lifetime limited, Padding and Rim – 5 year limited

**Playground Structures:** All GS MAX & GS Double MAX Systems – Unconditional Lifetime Functional Warranty; RP775 3-1/2" Gooseneck Pole – 10 year limited; RP776 3-1/2" Adjustable Pole – 10 year limited; RP777 4-1/2" Gooseneck Pole – 25 year limited; RP778 4-1/2" Adjustable Pole – 25 year limited; RP780 Mega Duty Pole – Lifetime limited.

**Gym Structures & Accessories:** Stationary, Side Fold and Swing Up Wall Mounted Structures – Lifetime limited; Height Adjuster – 10 year limited; A11067 Wall Mount Power Winch – 5 year limited; A11068 Portable 110 Volt Winch – 1 year limited; A11008 Fail-Safe Structure Catch – 10 year limited; A11200 Easy-Up Youth Mini Goal – 1 year limited on structure and rim, Lifetime limited on backboard

**Rims & Nets:** R10126 Single Ring Static – 2 year limited; R10226 Double Ring Static – Unconditional Lifetime; R10326 Heavy Duty Reflex – 2 year limited; R10426 GS Ultra Flex – 5 year limited; R10554 GS Collegiate Breakaway – 5 year limited; R10654 GS Pro Breakaway – 5 year limited; R10834 Home Court Reflex – 1 year limited; R10935 GS Premier Breakaway – 5 year limited; A11013 Steel Net – 2 year limited

**Institutional Backboards:** CB4272RG 42x72 Competition Glass – Unconditional Lifetime (indoor only); CB4272RGCV 42x72 Competition Glass Conversion – Unconditional Lifetime (indoor only); CB4872RG 48x72 Rectangular Glass – 20 year limited (indoor only); RB4254GC 42x54 Glass Conversion – Unconditional Lifetime (indoor only); CB3954 FG Fan-Shaped Glass – Unconditional Lifetime (indoor only); RB4260RS 42x60 Rectangular Steel – 10 year limited; RB3954RS 39x54 Rectangular Steel – 10 year limited; RB3954FS 39x54 Fan Steel – 10 year limited; RB3954RA 39x54 Rectangular White Aluminum – Lifetime warranty on direct mount pole systems; RB3654FCA 36x54 Fan Cast Aluminum – Lifetime warranty on direct mount pole systems, otherwise 10 year limited; RB3654FA 36x54 Fan White Aluminum – Lifetime warranty on direct mount pole systems, otherwise 10 year limited; RB4272RF 42x72 Rectangular Fiberglass – 10 year limited; RB4254RP 42x54 Rectangular Polycarbonate – Lifetime limited; RB4254RG 42x54 Rectangular Glass – Lifetime limited; RB3954 FP 39x54 Fan Polyethylene – Lifetime limited